



## ROOF MOUNTED FANS

# TH-MIXVENT Series

## Mixed Flow Fans



Range of roof mounted mixed flow fans supplied as standard for extract operation. The models 500 and 800 are manufactured from high strength injection moulded plastic, and models 1300 and 2000 from high grade pressed sheet steel. The bases are manufactured from sheet steel. The cowls are manufactured from pressed sheet steel (500 and 800 models) or spun aluminium (1200 and 2000).

All models incorporate a bird guard and base cable gland entry point as standard.

All metallic parts are **protected with a black epoxy-polyester weatherproof paint** coating.

The motor and impeller casing can be easily removed by 2 fixing clamps.

### Motors

All motors are IP44, Class B, equipped with **thermal protection** and **ball bearings greased for life**.

Electrical supply:

Single phase 230V-50Hz (Capacitor located inside the wiring terminal box).

All motor have two speed connections also suitable for voltage speed control using electronic or auto-transformer controllers.

### Additional Information

The motor and impeller casing can be removed and turned through 180° to provide supply air ventilation.

TH-MIXVENT

Roof mounted fans

## APPLICATIONS



Workshops



Commercial premises



Offices



Restaurants and cafes



Wine cellars Basements

### Flame retardant terminal box



Very **accessible wiring terminal box** in **flame retardant plastic V0**, with **capacitor located inside**

### Circular spigot coupling



Circular spigot coupling to facilitate the connection of circular, rigid or flexible ducting

### Bird-proof guard



## Technical characteristics

Before installation check that the product electrical characteristics listed on the data plate label (Voltage, power, frequency etc) match those of the intended electrical supply.

Model		Speed		Maximum absorbed power (W)		Maximum absorbed current (A)		Maximum air volume (m <sup>3</sup> /h)		Max. temp. (°C)	Sound pressure level* (dB(A))	Weight (Kg)
		(r.p.m.)		High speed	Low speed	High speed	Low speed	High speed	Low speed			
		High speed	Low speed									
TH-500/150	EXTRACT	2450	1800	50	45	0,23	0,18	470	355	-20/+60	49,5	3,8
	SUPPLY	2450	1800	50	45	0,23	0,18	505	380		45	3,8
TH-500/160	EXTRACT	2450	1800	50	45	0,23	0,18	470	355	-20/+60	49,5	3,8
	SUPPLY	2450	1800	50	45	0,23	0,18	505	380		45	3,8
TH-800N	EXTRACT	2500	2100	90	75	0,4	0,31	790	630	-20/+60	50	5,6
	SUPPLY	2500	2050	90	75	0,4	0,31	880	695		48	5,6
TH-800	EXTRACT	2500	2100	120	118	0,52	0,50	775	620	-20/+60	53	5,6
	SUPPLY	2500	2000	120	118	0,52	0,50	860	695		52	5,6
TH-1300	EXTRACT	2400	1800	170	120	0,83	0,52	1100	780	-40/+60	59,5	11,2
	SUPPLY	2400	1800	172	110	0,76	0,49	1150	845		58,5	11,2
TH-2000	EXTRACT	2480	1750	255	160	1,27	0,79	1725	1200	-40/+60	67	17,2
	SUPPLY	2480	1800	300	190	1,27	0,79	1650	1245		63,5	17,2

Sound pressure level at 3 m.

## Dimensions (mm)

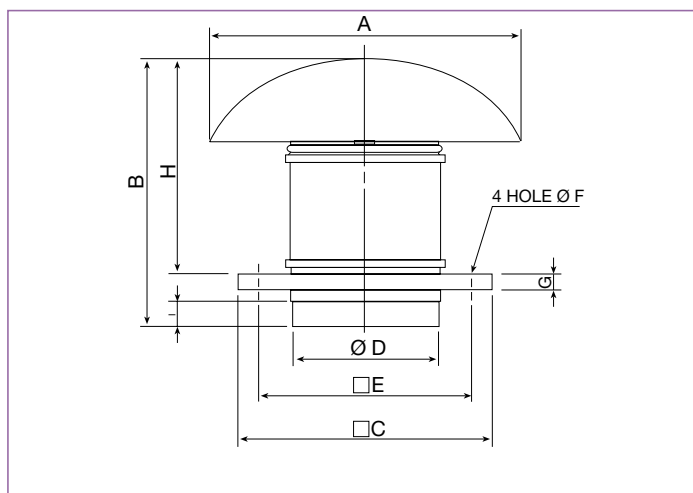

Model	A	B	C	D	E	F	G	H	I
TH-500/150	400	349	300	150	245	10	20	274	33
TH-500/160	400	339	300	160	245	10	20	274	33
TH-800 N	400	371	300	198	245	10	20	306	36
TH-800	400	371	300	198	245	10	20	306	36
TH-1300	546	457	435	248	330	12	20	372	42
TH-2000	735	544	560	312	450	12	20	450	50

## Acoustic characteristics

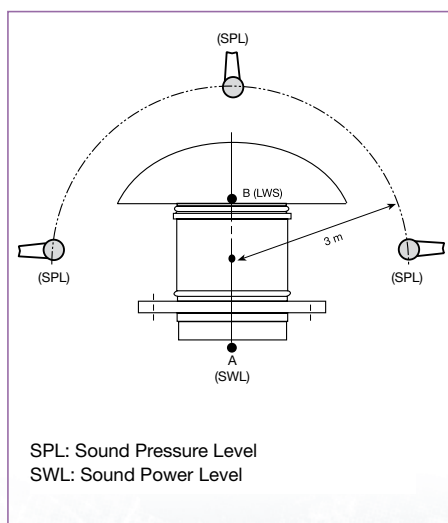

The values of the sound levels given in the technical characteristic chart are sound pressure levels measured in dB(A) at a distance of 3 m with the maximum airflow.

To obtain the sound power level at A or B, for extract operation, add to the sound pressure level (SPL Extract) given in the Technical Characteristic chart, the correction value shown in the following table.

Model		Sound power level for extract operation						
		Frequency bands Hz						
		125	250	500	1000	2000	4000	8000
TH-500	A	-7,5	-3	9	6	11	4	-2
	B	-7,5	6	13,5	17,5	14,5	4,5	-3
TH-800N	A	-7,5	3,5	8	9,5	14	9	0
	B	-4	7,5	15	16	14,5	9	1,5
TH-800	A	-7,5	3,5	8	9,5	14	9	0
	B	-4	7,5	15	16	14,5	9	1,5
TH-1300	A	-13,5	0	1	12	9	4	0
	B	-11	5,5	11,5	17,5	15	7	-0,5
TH-2000	A	-21,5	-7	-3	7	5,5	-2	-8,5
	B	-16,5	2,5	7	20	7,5	1	-8



## Performance curves - Extract operation

- Q = Air volume in, m<sup>3</sup>/hr and m<sup>3</sup>/s.
- Ps = Static pressure in mmWG and Pa.
- Dry air at 20°C and 760 mmHg.
- Performance data in accordance with ISO 5801 and AMCA 210-99 Standards.

HS: High Speed  
LS: Low Speed

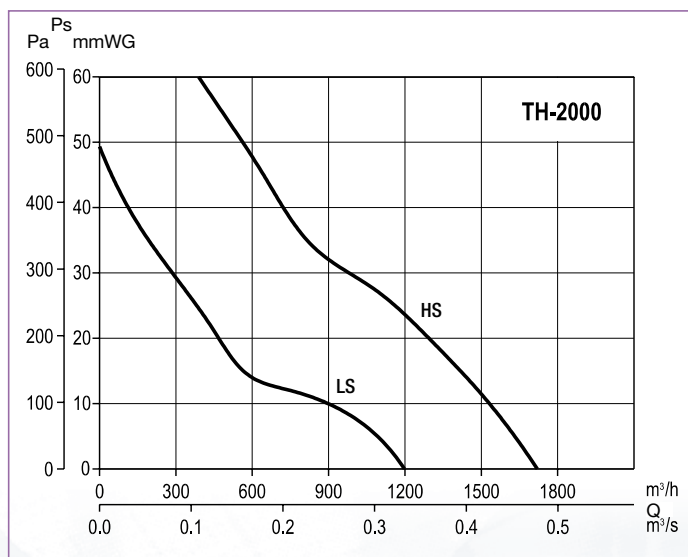
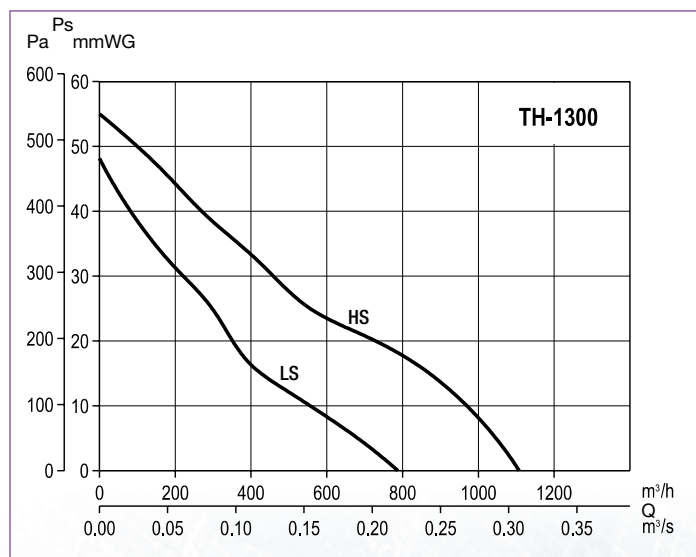
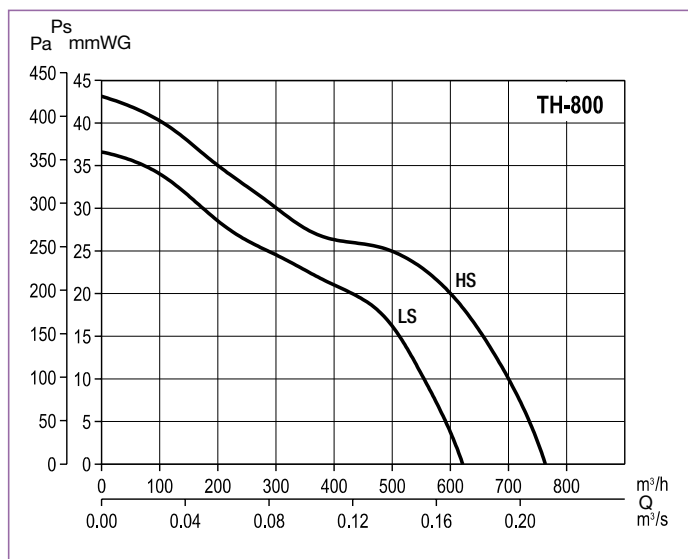
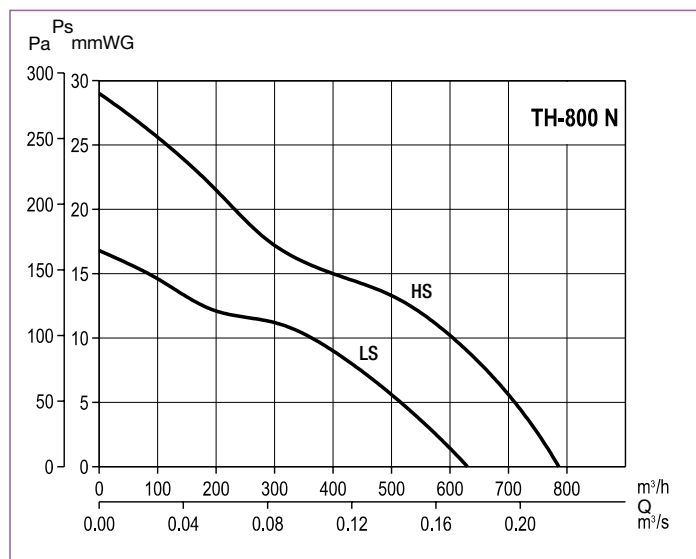
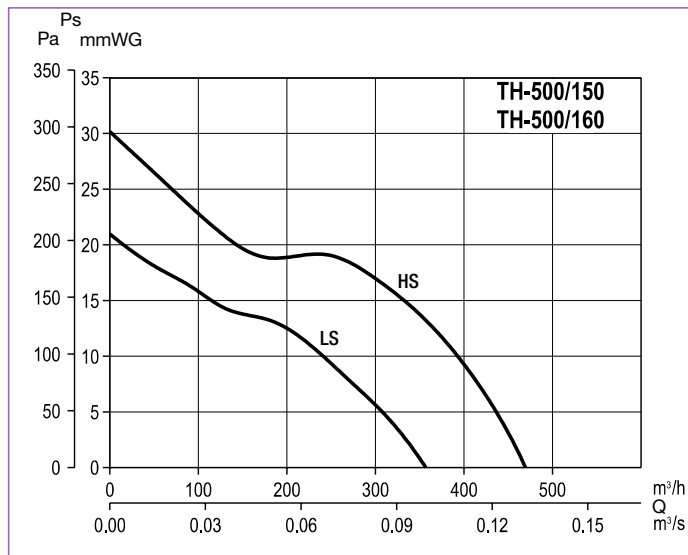

## ■ Performance curves – Supply operation

- Q = Air volume in, m<sup>3</sup>/hr and m<sup>3</sup>/s.
- Ps = Static pressure in mmWG and Pa.
- Dry air at 20°C and 760 mmHg.
- Performance data in accordance with ISO 5801 and AMCA 210-99 Standards.

HS: High Speed  
LS: Low Speed

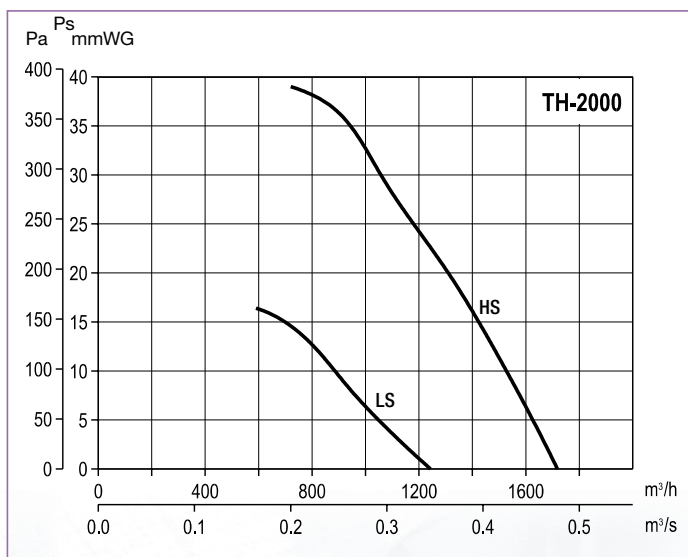
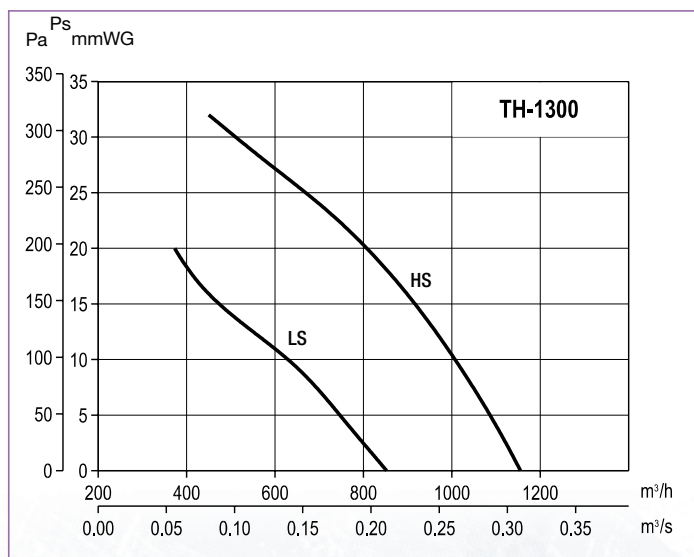
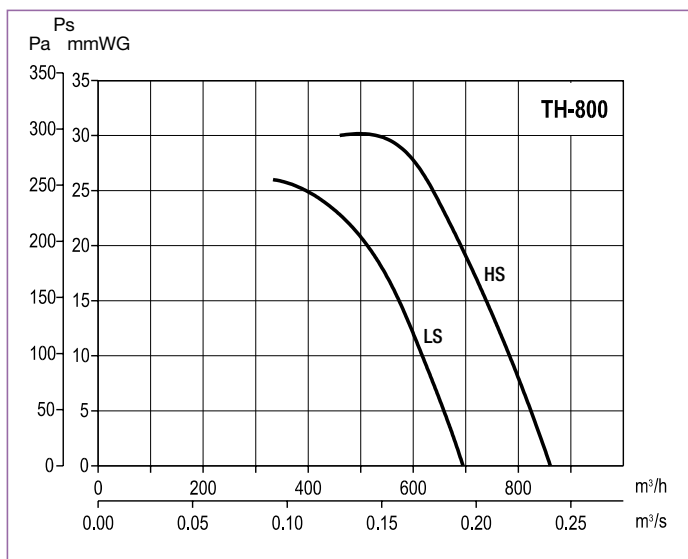
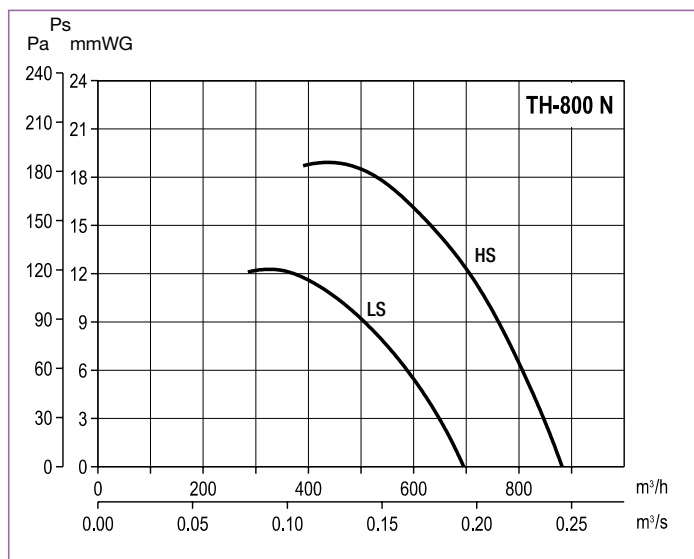
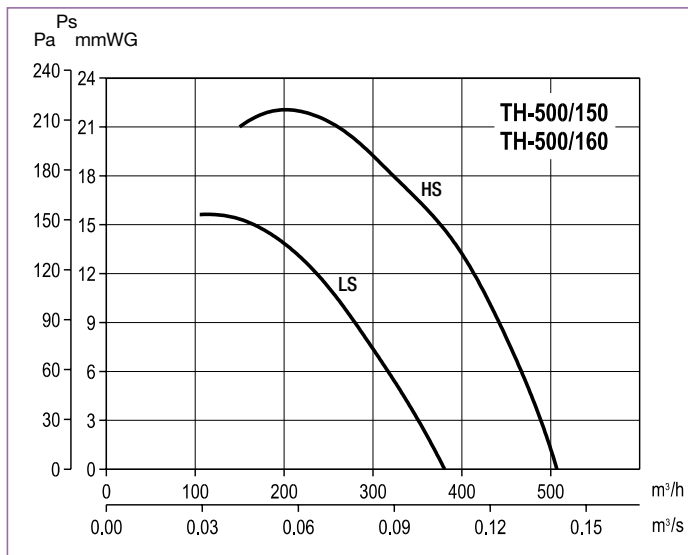

## ■ Mounting accessories

TH-MIXVENT  
Roof mounted fans

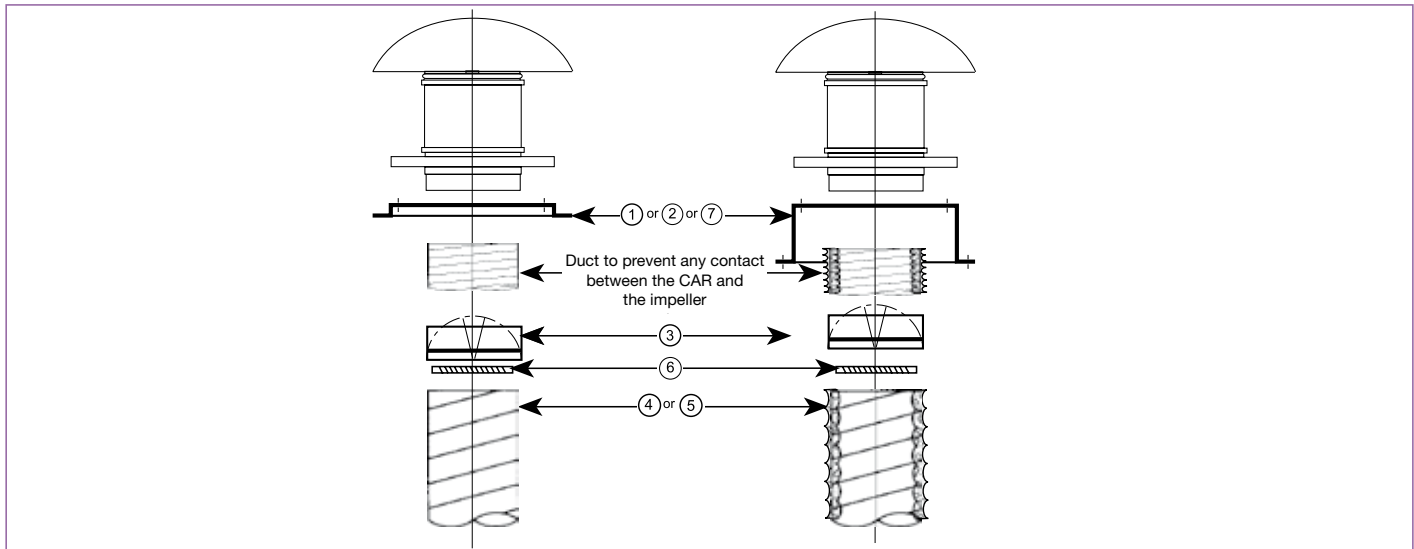

Model	① Sealing frame	② Flat roof upstand	③ Backdraft shutter	④ Flexible ducting	⑤ Flexible acoustic ducting	⑥ Worm drive clips	⑦ Support base for curb mounted installations
TH-500/150	JMS-300	JBS-300	CAR-150	GSA-150	GSI-160	CX-215	BI-3
TH-500/160	JMS-300	JBS-300	CAR-160	GSA-160	GSI-160	CX-215	BI-3
TH-800 N	JMS-300	JBS-300	CAR-200	GSA-200	GSI-200	CX-250	BI-3
TH-800	JMS-300	JBS-300	CAR-200	GSA-200	GSI-200	CX-250	BI-3
TH-1300	JMS-435	JBS-435	CAR-250	GSA-250	GSI-250	CX-315	BI-4
TH-2000	JMS-560	JBS-560	CAR-315	GSA-315	GSI-315	CX-315	BI-5

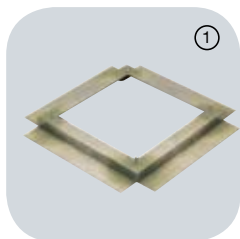

①

### Sealing Frame JMS:

- For mounting the roof fans on an up stand or base
- Provided with screws and gasket for a complete seal

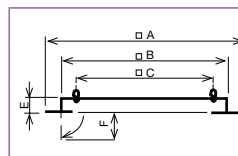

Model	A	B	C	E	F
JMS-300	470	290	245	50	70
JMS-435	600	420	330	50	70
JMS-560	725	545	450	50	70



②

### Flat Roof Up stands JBS:

- For mounting fans on flat roofs with no up stands
- Internal insulation to avoid condensation
- Provided with screws and gasket for a complete seal

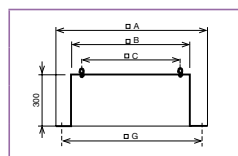

Model	A	B	C	E	G
JBS-300	470	289	245	300	380
JBS-435	600	419	330	300	510
JBS-560	725	544	450	300	635



⑦

### BI support base for inclined curb mounted installations:

- To ensure the proper installation of the BI product it is essential to specify the roof pitch angle and the distance between the roof beam profiles (as shown)

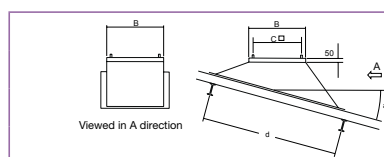

d: distance between the roof beam profiles

a: roof pitch angle (curb)

	B	C
BI-3	289	245
BI-4	419	330
BI-5	544	450



## ■ Mounting accessories



**CAR**  
Backdraft Shutter



**GSA**  
Flexible aluminium ducting

**GSI**  
Acoustic aluminium ducting



**CX**  
Worm drive clips



**SIL**  
Sound attenuator

## ■ Electrical accessories



**REGUL-2 and COM-2**  
Two speed switches



**REB**  
Electronic, single phase speed controller

